

Tpure Bone Level Implant

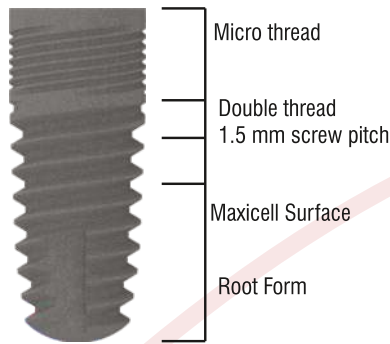





Tpure bone level implant offers esthetic and safe solutions to all indications with its design and wide range of superstructure line providing cemented, screw-in, overdenture, custom and cad-cam solutions. (Please refer to the Product Catalogue for superstructure line.)

Specifications of Tpure Implant:



Diameters & Lengths :

T4 Bone Level Implant offers four different diameter and length options as shown below;

			
Ø 3.4	Ø 3.8	Ø 4.2	Ø 5.0
L: 8	L: 8 T43808	L: 8 T44208	L: 8 T45008
L:10 T43410	L:10 T43810	L:10 T44210	L:10 T45010
L:12 T43412	L:12 T43812	L:12 T44212	L:12 T45012
L:14 T43414	L:14 T43814	L:14 T44214	L:14 T45014

Placement Recommendations:

The chart contains recommendations for surgical application of Tpure Bone Level Implants. Clinician should assess the patient, case and the targeted final restoration.

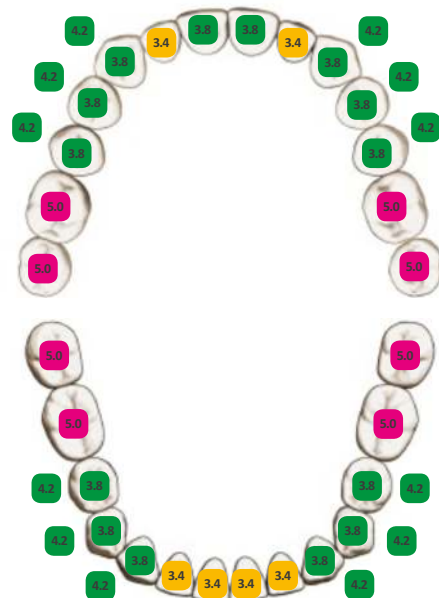

Implant Site Preparation and Placement

Bone preparation for Nucleoss Tpure Bone Level Implant is shown below:

Ø 3.4 L: 12 mm

Ø 3.4 Implant Drill Protocol for D3/D4 bone

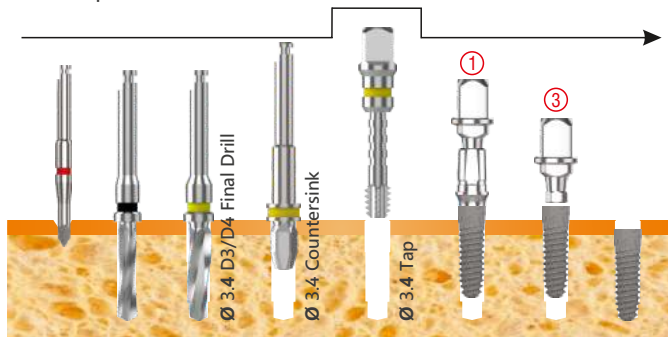

Ø 3.4 Implant Drill Protocol for D1/D2 bone

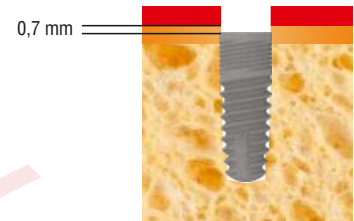

Ø 3.8 L: 12 mm

Ø 3.8 Implant Drill Protocol for D3/D4 bone

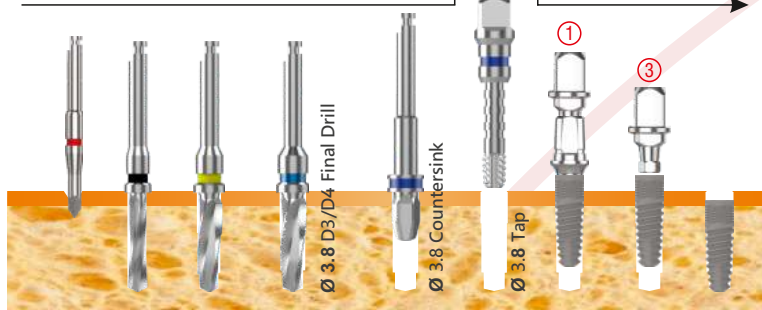

Ø 3.8 Implant Drill Protocol for D1/D2 bone

ATTENTION: Please keep in mind while planning the surgery; The site prepared with the surgical drills is 0.7 mm longer than the implant length to support healthier bone formation around the implant neck.

Ø 4.2 L: 12 mm

Ø 4.2 Implant Drill Protocol for D3/D4 bone

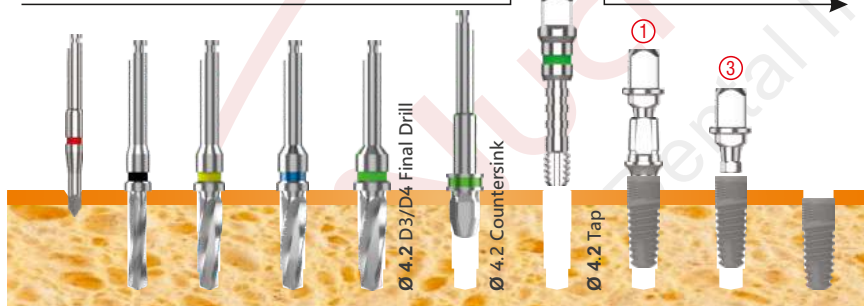

Ø 4.2 Implant Drill Protocol for D1/D2 bone

Ø 5.0 L: 12 mm

Ø 5.0 Implant Drill Protocol on D3/D4 bone

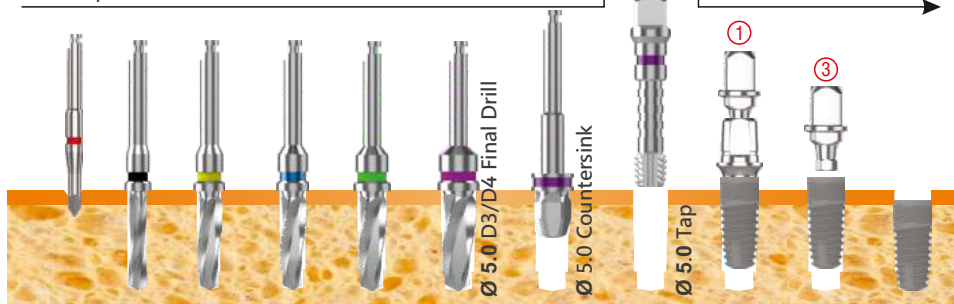

Ø 5.0 Implant Drill Protocol for D1/D2 bone

Tpure IMPLANT & DRILL COMPATIBILITY



The tolerance of the site prepared with the **final drills** to the implant is 0,24 mm Please refer to the drawings before.

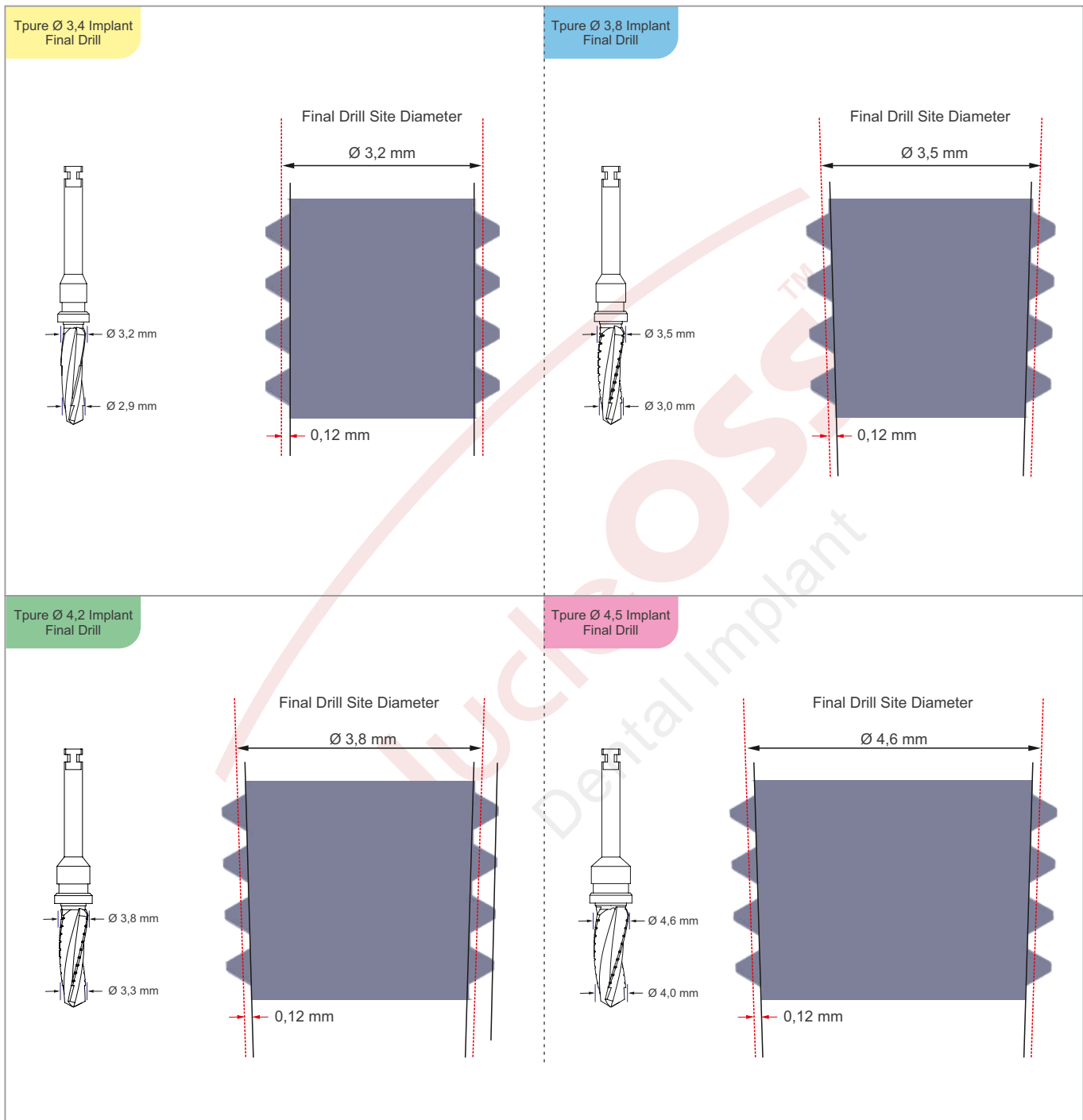

Handling of Tpure Implant:



Tpure implants are provided with a standart abutment in the hermetic tube. The abutment also acts as a transfer part.

The implant is transferred from the vial to the surgical field either with the ratchet, hand or contra-angle as shown below:



ATTENTION: In order for safe transfer of the implant from the vial to the surgical field; Tightening part should fit to abutment head completely. (1) The surgeon should evaluate each case and decide about how much of the implant should be inserted to the implant bed with the transfer part. Insisting to use the transfer part in hard bone may cause damages in the implant hex. Therefore, it is suggested to remove the transfer part (2) when initial stability within the bone is achieved and carry on the procedure with the mounting instrument. (3) (please see the figure below)

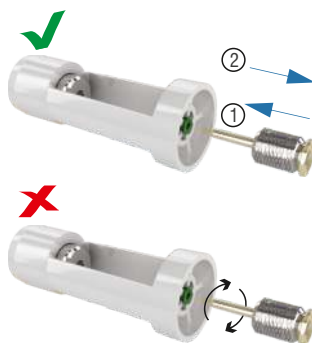
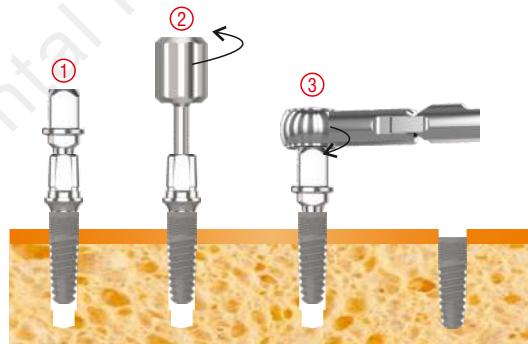

Handling the cover screw;

in order to transfer the cover screw from the tube, insert the hex driver into the hex slot fully and pull it backwards in the same axis.